



## Experimental Investigation of Solar-Thermoelectric Power Generator

Amira Omar, Mostafa Ali and M. Halawa

Mech. Department, Faculty of Engineering, Al Azhar University, Cairo, Egypt

**Abstract:** Due to traditional electricity power shortage. Photovoltaic (PV) system is a good choice to overcome this problem. The PV modules are used to capture and convert solar energy into electricity. The PV system were designed, constructed and enhanced by using thermoelectric (TE) device which act as a generators increasing the total output power. The present modified system consist of PV solar plate which faces the solar radiation from the top while the TE modules (hot junction) are attached on the back side of the PV plate. The experimental results are performed with two arrangements of thermoelectric devices in the back of PV solar plate. The study is conducted to include enhancement of temperature difference through the TE module by applying excess cooling by the forced convection fan. Comparison was made between the obtained results from the present modified (PV/TE) system and the traditional PV system. Using PV/TE system, the efficiency increases to reach about 26.6 % while it was 17.56 % in the absence of TE system at symmetric case arrangement. But in case of unsymmetrical arrangement using PV/TE system the efficiency increases to reach to 27.2 % while it was 18 % in the absence of TE system.

[Amira Omar, Mostafa Ali and M. Halawa. **Experimental Investigation of Solar-Thermoelectric Power Generator.** *J Am Sci* 2020;16(7):12-19]. ISSN 1545-1003 (print); ISSN 2375-7264 (online). <http://www.jofamericanscience.org>. 3. doi:[10.7537/marsjas160720.03](https://doi.org/10.7537/marsjas160720.03).

**Keywords:** Thermoelectric generator, Photovoltaic cell, conversion efficiency, Hybrid PV/TE system

### 1. Introduction

The most stable, long-term, and readily available worldwide energy source is that of solar energy. Other alternative energy technologies such as fuel, wind energy, and thermoelectric will provide some assistance in meeting our future energy needs. During operation of the photovoltaic (PV) panel, a portion of the solar irradiation converts to thermal energy and increases the temperature of the PV cells, causing the efficiency to decrease. Many hybrid systems will be needed, and thermoelectric can work in tandem with many of these other technologies, especially solar, as it can use the heat source provided by solar radiation. The cell's operating temperature has a significant effect on its electrical conversion efficiency; so that the power output of the module varies inverse proportional with the operating temperature of the cell [1].

The Thermoelectric power generator is a device which converts the heat energy into the electrical energy. It works based on the principle of Seebeck effect. The Seebeck effect is the conversion of temperature difference directly into electricity. Thus, the Thermoelectric power generator is made by using PN semiconductors where P and N are connected in series. The Peltier plate converts heat energy into electrical energy using Seebeck effect. When providing heat to the Peltier plate at one side of the plate gets hot at another side of the plate gets cold

means that the temperature of both ends are different is called the Seebeck effect [2].

Rabari [3] has researched the nano-structured TE model under natural air convection conditions. The results show that the generation of electric current increases as hot surface temperature increases. The electrical efficiency of TEs is poor because of a large amount of heat loss caused by the presence of irreversible convection heat transfer. Additionally, the heat sink can integrate with the TE to maintain the temperature difference between the heat side and the cold side. [4-5].

The PV/TE system with mono-crystalline silicon solar cells has been researched by Pang et al [6]. A combined PV/TE system was designed by integrating a TE with plate-fin and pin-fin heat sinks on the back of the PV. The cold side temperature of the TE can be maintained around 25–30 8C by integrating with heat sinks. The photovoltaic conversion efficiency of the PV/TE integrated system is increased by 3.9% and the total system efficiency is increased by 5.9%.

Ershuai Yin et al [7], assumed solar irradiance is constant (1000 W/m<sup>2</sup>) and ignoring the influence of changing solar radiation with time. Study was theoretical and detailed one-day. The thermal concentration ratio was discussed and optimized to increase the one-day average efficiency Influences of photovoltaic efficiency temperature coefficient,

thermoelectric Z value, water cooling mass and velocity were discussed.

Ma Liwanag et al. [8] propose a model of the TE device to help lower temperature of the PV modules which will optimize its performance through an increase in the generated output. The PV-TE system was simulated using MATLAB software, and results was that there is potential in using TE technology as coolant and generator improving the performance of the PV device. Experiments and actual deployment also reveal an improved output for the combined PV-TE system.

Wang et al. [9] Make studies on heat loss rate in PV panels with lower conversion efficiency, applying TEG on this kind of solar cells is more effectual to enhance the total efficiency of the module found that the efficiency of the hybrid system comprising of dye-sensitized solar cell and TEG could be increased by 13% compared to that of single PV (photovoltaic).

Park et al. [10] make an experimental and theoretical studies to optimize lossless hybridization conditions for a hybrid crystalline PV cell mounted on a commercial bismuth telluride based TEG, for achieving a 30% PV relative efficiency improvement at a temperature gradient of only 15°C.

A.R. Amelial et al [11] proposed the cooling system using thermoelectric cooling (TEC) and water block heat sink for enhancing the PV panel output power they concluded that by the hybrid cooling system combining TEC module and the water block heat sink could improve the output performance of the PV panel. By reduction temperature of the PV panel by 16.04 %, the average output power of the PV panel has been boosted up from 8.59 W to 9.03 W.

Jeyashree et al [12] presented optimization of the geometry of thermoelectric devices using the analytical expression. The geometry optimization helps in achieving a maximum power output and minimizes the consumption of thermoelectric materials. The performance of a 4cm×4cm bismuth telluride based thermoelectric generator was analyzed with solar heat, and average power of 0.0552 W was obtained. A 5W, 40cm×15cm solar panel is analyzed with solar heat and the average power output is 2.222W. When the 40cm×15cm solar panel is combined with 4cm×4cm thermoelectric generator experimentally, the average power obtained is 2.2794W. Performance is improved by cooling the cold side of 4cm×4cm thermoelectric generator with an ice block, and average power of 2.45 W was obtained experimentally. When the entire area of the solar panel is combined with thermoelectric generator, the estimated power of 4.292 W was obtained. Similarly when the entire area of the solar panel is combined with the cooled thermoelectric generator

and estimated power output of 10.772 W was obtained.

Zhu, Wei, et al. [13], proposed improvement hybrid PV-TE generation system. The hybrid system was placed in the enclosure to reduce convection losses. A thermal absorber was introduced to concentrate and conduct thermal energy. In particular, numerical simulations and theoretical calculations have also been performed to optimize the heat flow process. The proposed PV-TE hybrid system is built and measured in the open air. Furthermore, a cost and power lumped analysis of this PV-TE hybrid configuration was proposed to estimate its economic feasibility.

In this present work, two arrangement types of hybrid TE energy sources have been proposed. TE modules are fixed to the rear of PV panel to decrease its temperature and consequently improve the efficiency of the panel. The cooling of TEC by fan air-cooled heat sink improve the output of the PV panel. These both devices act as the cooling system to reduce the PV panel temperature by extracting the excess heat. These both devices act as the cooling system to reduce the PV panel temperature by extracting the excess heat. The different arrangement of TEC for the system also has been compared with the same type of the PV panel only. Section 2 explains the materials used in the experimental study. This section also presents the methodology of the experiment. Section 3 analyses and discussed briefly on the results produced. Meanwhile, the last section shows the conclusion of this proposed study.

## 2. Methodology

### 2.1. Material preparation

#### 2.1.1 PV panel

In present work, a Mono-crystalline silicon (mc-Si) solar cell with the rating power of 50 W has been used. The surface area was 0.3618 m<sup>2</sup>. This PV panel able to generate the open-circuit voltage boost to 21.6V, meanwhile 3.17A for short-circuit current. The technical characteristics of photovoltaic panel in present in Table1.

**Table 1. Solar Panel Specifications**

Characteristics value	Description
Maximum Power	50 W
Maximum Power Voltage	18V
Maximum Power Current	2.86A
Short Circuit Current	3.17A
Open Circuit Voltage	21.6V
Dimensions, (mm)	540*670*25

#### 2.1.2 TEC module

In this study the TEC module was used as an alternative method to reduce the operating temperature

of the PV panel achieving the maximum output power. In Table 2, the specification data for the use of the TEC module are listed. As showed in this table, the typical TEC module is made of Bismuth Telluride (Bi<sub>2</sub>Te<sub>3</sub>) based alloy which known as the most commercial module in TEC market. Through Table 2, it shows that the selected TEC module which was constructed by 127 numbers of thermocouples can generate 6 A of maximum current and 15.2 V for the maximum voltage. Besides that, this TEC module is operated at 12 V of a direct current (DC) operated at 12 V of a direct current (DC). The technical characteristics of TEC are listed in Table2.

**Table 2. TE Module Specifications**

Characteristics value	Description
Model	TEC1-12706
Material	Bismuth Telluride (Bi <sub>2</sub> Te <sub>3</sub> )
No. of thermocouples	127
Dimension module	40 x 40 x 4.3 mm
Maximum current	6 A
Maximum voltage	15.2 V
Operational voltage	12 V (DC)

### 3. System description and experimental setup

By using LabVIEW platform, Arduino Uno Board is based microcontroller and Arduino linx toolkit for LabVIEW, we acquired, analyzed, and processed signals from our system, also to generate control signals. Arduino Uno Board contains 14 Digital Input/output channels. Referring to Fig. 2, there are two control signals one for cooling system activation/deactivation and the another for inserting/drawing the load. Control signals need an interfacing stage to amplify the signal produced by Arduino which is achieved by Relay Board, relay board is a 4-channel module, so we can produce four

control signals at the same time, according to our power supply we selected the operating voltage for relays using the built-in jumper pins. By energizing the first relay (R1), the Normally Open terminal is in contact with the common terminal, so the cooling system starts to operate with its full power, while energizing the second relay (R2), the load is inserted to the system drawing current from the source (PV-Panel). The load is about 5.5 ohms in shape of two parallel thermal resistors 11 ohms plus one ohm in series, so the total resistance is 6.5 ohms.

Acquired signals from the system are

1- ACS712 current sensor: it's used to measure current supplied from the TEC device ( $I_{TE}$ ) and photovoltaic panel ( $I_{PV}$ ).

2- DC Voltage sensor module it's used to measure the output voltage from the TE device ( $V_{TE}$ ) and photovoltaic panel ( $V_{PV}$ ).

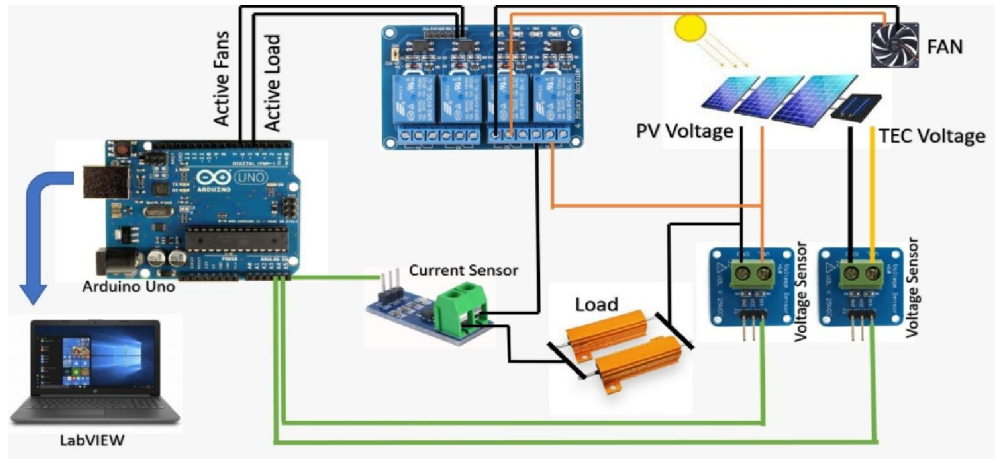
3- The temperature of the PV panel ( $T_{PV}$ ) can approximate the temperature of the test point, which is the backside temperature of the PV panel that can be measured using LM35 the temperature sensor that has sensing range varies from -55 to 150 °C and outputs an analog signal to the Arduino, this analog signal corresponds to 10mV/°C linearly.

All used sensors are connected to Arduino Analog Input channels (AI), which convert the analog signal to digital signal to be processed. ADC is a built-in unit inside Arduino Board which converts from analog to digital signal. Arduino Uno Board contains six analog input channels. Power supply is used to operate relay module board and cooling system while the Arduino Board is energized by USB cable connected to the laptop. The 5V output pin in Arduino board is used to energize all sensors, while GND terminals are used to make a common ground between all sensors, power supply, and relay module.



**Figure (1): Solar panel**

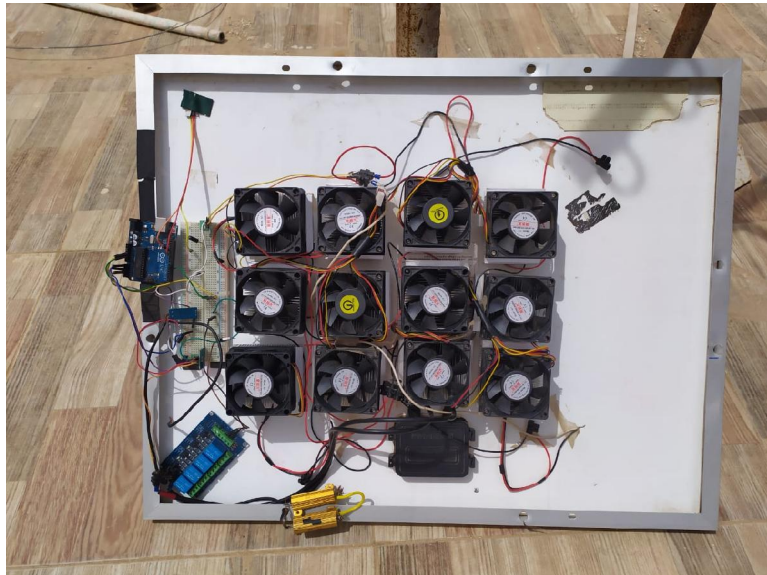




**Figure (2):** A Block Diagram of the experimental setup.

A Block Diagram of the experimental setup is shown in Fig. (2) consists of the following main components: one mono crystalline PV-modules, a twelve commercial bismuth telluride (TECs) is

integrated with a twelve aluminium heat sink at the back side of photovoltaic cooling by twelve electric fans. Also, control unit (lab VIEW + Arduino), Relay, thermal-resistance, voltage sensor and current sensor.



**Figure (3):** A photo of the back solar panel with TEC with fan cooling

#### 4. Hybrid PV-TEC efficiency

The mathematical relation for calculation of electrical efficiency for PV cell from measured test data is presented in Eq. (1) [14]. All parameters involved in this equation were measured in the current experiment. The photo panel efficiency can be extracted directly from the experimental results as can be seen in Eq. (1).

The photovoltaic output power is obtained by multiplying the corresponding values of current and voltage can be expressed as follows in Eq. (2)

$$\eta_{PV} = \frac{P_{PV}}{A_{PV} G} \quad (1)$$

$$P_{PV} = I_{PV} V_{PV} \quad (2)$$

where,

$\eta_{PV}$  = Electric conversion efficiency of photovoltaic panel

$V_{PV}$  = Maximum Voltage of photovoltaic panel

$I_{PV}$  = Maximum current of photovoltaic panel

$G$  = Total solar radiation intensity, 1000w/m<sup>2</sup>

$A$  = Area of PV Panel, m<sup>2</sup>

$P_{PV}$  = Maximum output power of photovoltaic panel, w

The efficiency of the TE can be calculated as follows in Eq. (3)

$$\eta_{TE} = \frac{P_{TE}}{A_{TE} G} \quad (3)$$

where,

$\eta_{TE}$  = Electric conversion efficiency of thermoelectric cooler

$V_{TE}$  = Maximum voltage of thermoelectric cooler

$I_{TE}$  = Maximum current of thermoelectric cooler

$G$  = Total solar radiation intensity, 1000w/m<sup>2</sup>

$A_{TE}$  = Area of thermoelectric cooler, m<sup>2</sup>

$P_{TE}$  = Maximum output power of thermoelectric cooler, w

The input electrical power to thermoelectric cooler in watts is

$$P_{TE} = I_{TE} V_{TE} \quad (4)$$

the total power output system,  $P_{PV}$ , can be calculated as:

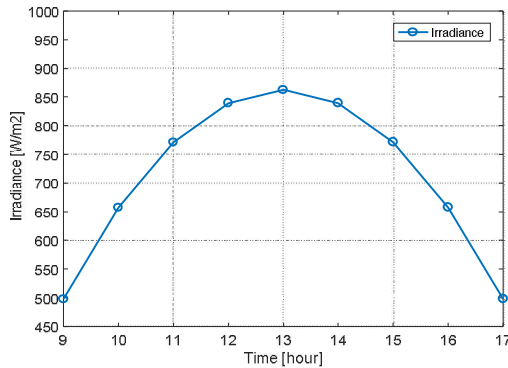
$$P_{PV-TE} = P_{PV} + P_{TE}$$

Consequently, the efficiency of the PV/TE hybrid system,  $\eta_{PV/TE}$ , can be expressed as follows: [15, 16]

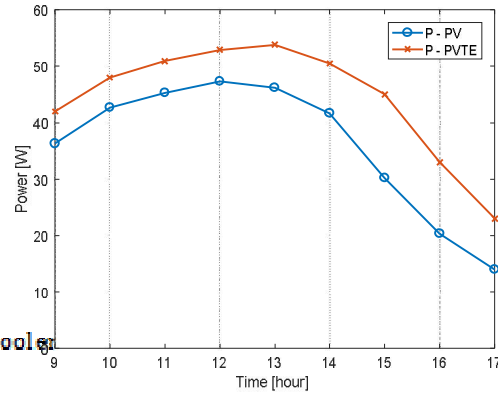
$$\eta_{PV/TE} = \frac{P_{PV} + P_{TE}}{AG} = \eta_{PV} + \eta_{TE}$$

### 5 Experiment Results

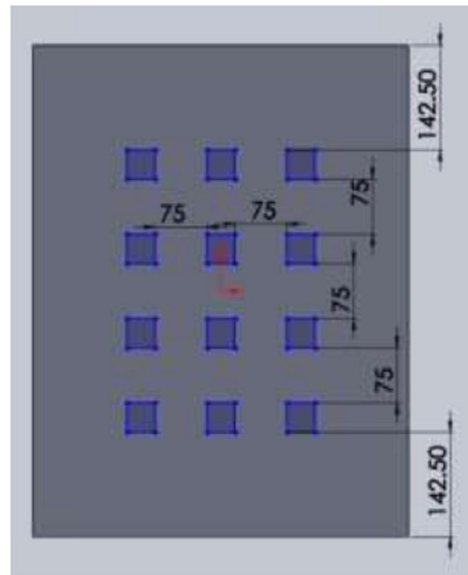
Fig.4. shows the results of solar irradiance variation on the PV panel (w/m<sup>2</sup>) versus time. From the figure, it is clear that the maximum value of the incident radiation reaches about 862.4 (w/m<sup>2</sup>) at the location of 10th of Ramadan city-Egypt. The position of PV plate is latitude 30° at 13 noon. The solar radiation intensity (w/m<sup>2</sup>) is measured by Pyranometer.



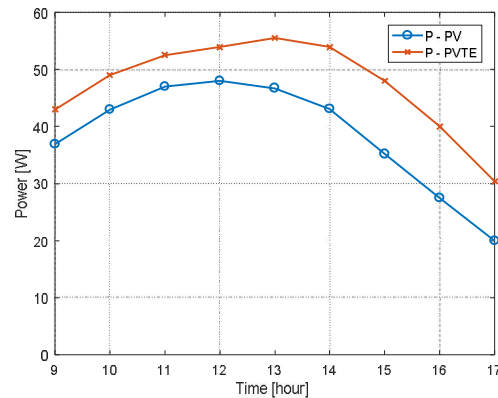
**Figure (4):** Irradiance variation with time (May 5, 2020 -10<sup>th</sup> of Ramadan city, Egypt).



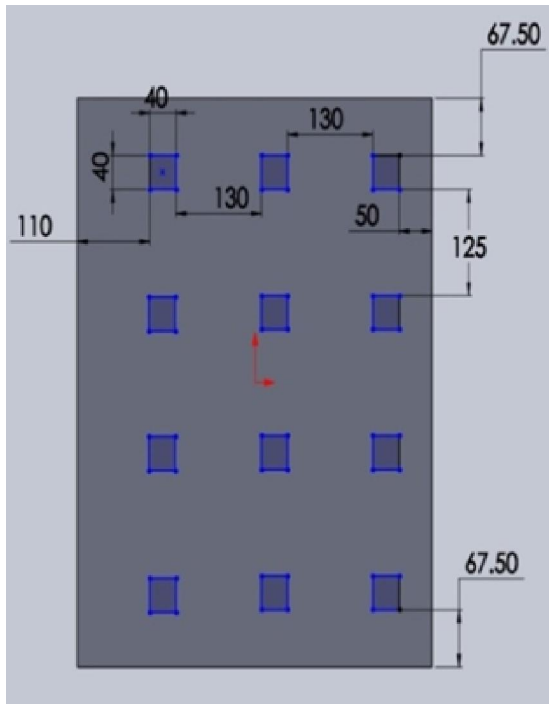
**Figure (5.a):** Comparison of the experimental output power for the two cases PV-TE system and PV only of 12TE module symmetric arrangement.



**Figure (5.b):** Symmetric TE distribution



**Figure (6.a):** Comparison of the experimental output power for the two cases PV-TE system and PV only of 12 TE module unsymmetric arrangement.



**Figure (6.b):** Unsymmetrical TE distribution

**Figure (5.a)** shows the comparison of the gained power with and without 12TE element placed under the PV plate with the arrangement shown in **Figure (5.b)**.

As shown from **Figure 5.a** the generated power is increased by about 16% by applying TEC when compared by the case of its absence. The latter result is interpreted as follow:

- TEC elements decrease the back temperature of PV plate and consequently the solar generated power increases.

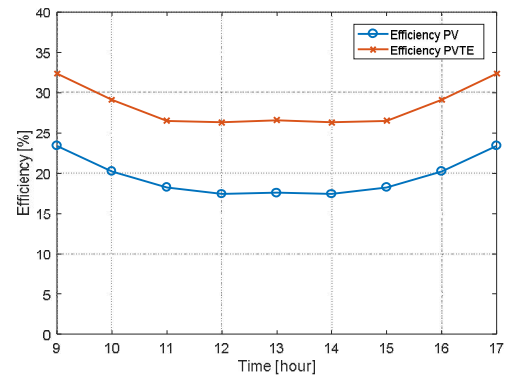
- Add to that the TEC element generates power under the temperature difference of the back PV plate temperature and ambient temperature.

It worth to note that the experiments were performed under two arrangements of TEC at the back of the PV plate.

These two arrangements are shown in figure 5.b and 6.b. The results of the solar generated power was represented in figure 5.a and 5.b respectively.

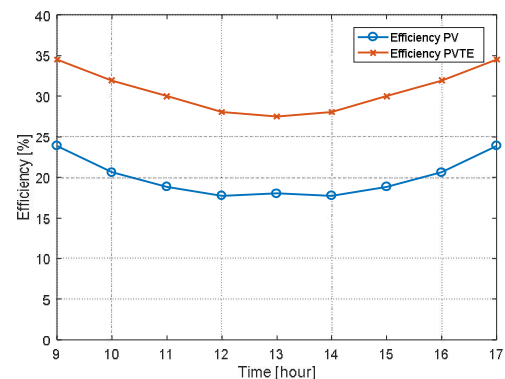
The power generated in the second case. Unsymmetrical case figure 6.a and 6.b is more than the first symmetrical case figure 5.a and 5.b.

The latter results are attributed to the turbulent flow arising from the unsymmetrical TEC distribution.



**Figure (7):** Comparison of the experimental efficiency of the PV only with that of system for the symmetric arrangement of 12TEC

Figure7 reveals the efficiency of solar energy gained by photovoltaic and photovoltaic with integrated TEC system distributed symmetrically at the back side of the photovoltaic plate. It is clear that the efficiency of the latter system exceeds the first one (photovoltaic only) by about 51.4 % as a mean value. This is due to the excess power generated from the TEC at the backside of the photovoltaic panel. The deviation in efficiency value between the two systems is maximum at 12 pm up to 3pm, whereas it is minimum near the sun rise and sun set. Near the two prementioned times the efficiency exceeds 51.4 % for the integrated PV and TEC system owing to the term (G.A) existed in the dominator of the thermal solar efficiency, equation ( 1 ). Where G represents the solar irradiance which has a lower values at that two times (sunrise and sunset) see Figure 4.

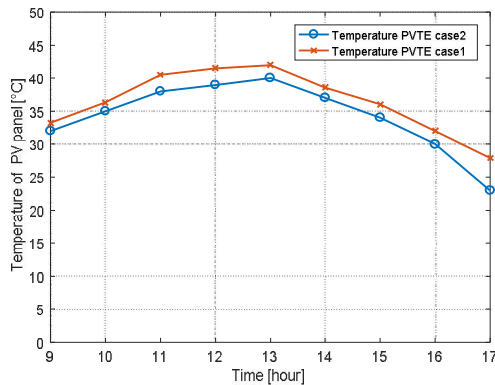


**Figure (8):** Comparison of the experimental efficiency of the PV only with that of system for the un-symmetric arrangement of 12TEC

Figure 8 shows the same results of efficiency development with time all over the day.

The TEC units are not imposed uniformly, see figure 6.b at the backside of the PV panel.

By comparing the results of efficiency values appear in Figures 8, it can conclude that the efficiency increases slightly than that appear in figures 7 with symmetrical distribution which is due to the turbulence in the flow of non-uniform distribution.



**Figure (9):** Comparison of the experimental Temperature of the PV only and the hybrid system (PV-TE) with the symmetric and un-symmetric of 12TEC module.

Figure 9 shows the temperature distribution at the backside of the photovoltaic plate under the following conditions:

- 1- Case 1 symmetrical distribution of the TE elements, fig 5.b.
- 2- Case 2 unsymmetrical distribution, fig 6.b.
- 3- Forced cooling of the atmospheric air surrounding the TE elements to create larger temperature difference between the two ends of TE elements.

As shown from fig9, case2 experiences larger temperature and consequently generates more power from TE elements and also larger efficiency.

## Conclusion

From the preceding results, it can conclude the following concluding remarks:-

- 1- Putting the thermoelectric elements at the backside of photo-voltaic plates, generates power due to the difference of temperature between the two ends.
- 2- The result of total power is increased by 20% in case 2 unsymmetrical distribution, due to the addition of TE elements. Also, the total power is increased by 16% in case 1 symmetrical distribution.

3- The results the efficiency is increased by 51.4% due to the addition of TE elements in the case of symmetrical distribution and 52.7% in the case of un-symmetrical.

4- By changing of the distribution of the TE elements (symmetrical and un-symmetrical), it was found a more power and efficiency is obtained in the case of unsymmetrical case due to the turbulence created there.

5- The average temperature in case 1 is 30.8°C, and average temperature in case 2 is 32.8°C.

6- The average output power has been increased from 46.206 W to 53.81 W in case of symmetrical arrangement. While, in unsymmetrical case the average output power has been increased from 46.6 W to 55.5 W.

## Reference

- 1 Dubey, Swapnil, Jatin Narotam Sarvaiya, and Bharath Seshadri. "Temperature dependent photovoltaic (PV) efficiency and its effect on PV production in the world—a review." *Energy Procedia* 33 (2013): 311-321.
- 2 U. Pau and P. Adour, *Energy Conversion and Management*, 140, 167-181, (2017).
- 3 R. Rabari, S. Mahmud, A. Dutt, *Int. Commun. Heat Mass Transfer* 2014, 56, 146–151.
- 4 Hsu, Cheng-Ting, et al. "Experiments and simulations on low-temperature waste heat harvesting system by thermoelectric power generators." *Applied Energy* 88.4 (2011): 1291-1297.
- 5 Hsiao, Y. Y., W. C. Chang, and S. L. Chen. "A mathematic model of thermoelectric module with applications on waste heat recovery from automobile engine." *Energy* 35.3 (2010): 1447-1454.
- 6 Pang, Wei, et al. "Electrical characteristics of a hybrid photovoltaic/thermoelectric generator system." *Energy Technology* 6.7 (2018): 1248-1254.
- 7 Yin, Ershuai, Qiang Li, and Yimin Xuan. "One-day performance evaluation of photovoltaic-thermoelectric hybrid system." *Energy* 143 (2018): 337-346.
- 8 Montayre, Ma Liwanag O., and Erees Queen B. Macabebe. 2015 "Feasibility Study on Thermoelectric Conversion to Improve Photovoltaic Operation."
- 9 Wang, Ning, et al. "A novel high-performance photovoltaic-thermoelectric hybrid device." *Energy & Environmental Science* 4.9 (2011): 3676-3679.

- 10 Park, Kwang-Tae, et al. "Lossless hybridization between photovoltaic and thermoelectric devices." *Scientific reports* 3 (2013): 2123.
- 11 Amelia, A. R., M. A. Jusoh, and Ida Shamira Idris. "Effect of Thermoelectric Cooling (TEC) module and the water flow heat sink on Photovoltaic (PV) panel performance." *EPJ Web of Conferences*. Vol. 162. EDP Sciences, 2017.
- 12 Jeyashree, Y., et al. "Solar Energy Harvesting using Hybrid Photovoltaic and Thermoelectric Generating System." *Global Journal of Pure and Applied Mathematics* 13.9 (2017): 5935-5944..
- 13 Zhu, Wei, et al. "High-performance photovoltaic-thermoelectric hybrid power generation system with optimized thermal management." *Energy* 100 (2016): 91-101.
- 14 Pramod N, K. S. Shashishekar," Computational Analysis of Photovoltaic Cell with Thermal Sink" *JEST-M*, Vol 2, 2013.
- 15 He, Wei, et al. "A study on incorporation of thermoelectric modules with evacuated-tube heat-pipe solar collectors." *Renewable Energy* 37.1 (2012): 142-149.
- 16 Van Sark, W. G. J. H. M. "Feasibility of photovoltaic-thermoelectric hybrid modules." *Applied Energy* 88.8 (2011): 2785-2790.

7/8/2020